

2in1 Digital AngleRule Instruction

Technical Data:

Measuring Range: 000.0° ~ 999.9°
 (more than 999.9° incorrect display)
 Working Temperature: 0° C ~ +50° C
 Working Humid: ≤85%RH
 Working Current: ≤100μA
 Resolution: 0.1°
 Accuracy: 0.3°
 Battery: CR2032 3V Lithium Battery

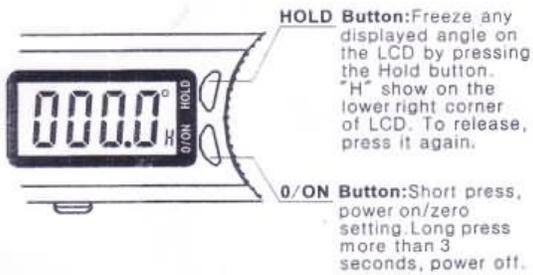
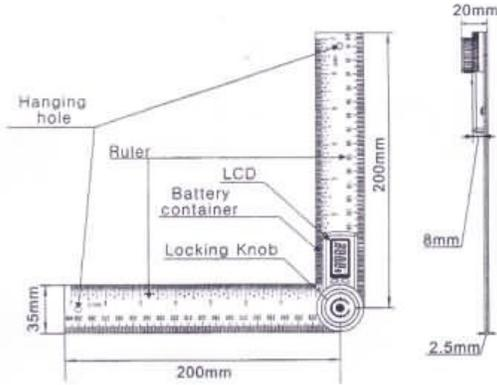

Operating Instruction:

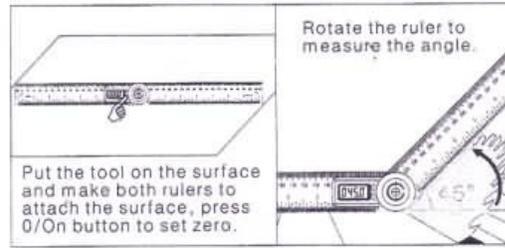
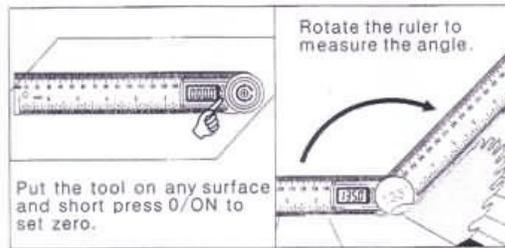
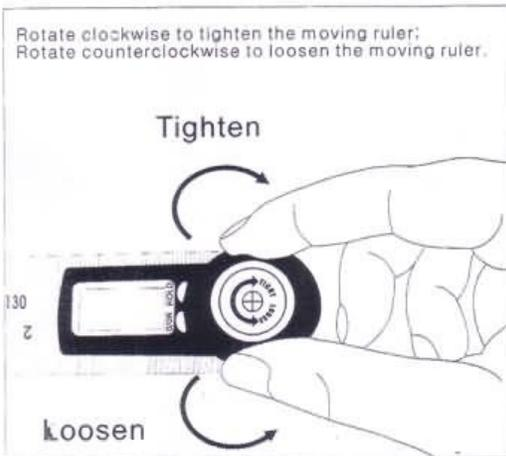

Battery:

1. To replace battery, push the protrudent on the bottom of the LCD, the edge of battery container is shown on the upper side of the LCD. (Pic 1).
2. Pull the battery container out (Pic 2).
3. The negative pole of battery is upside, positive pole is downside. (Pic 3).
4. Push the battery container back. (Pic 4).

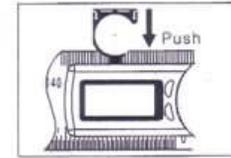
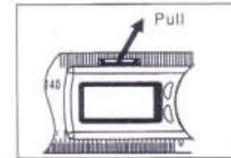
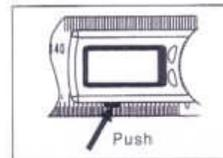

Trouble Shooting:

Problem	Possible Cause	Solution
No display or ambiguous	Lower voltage, no battery or incorrect installation of battery	Reinstall battery or replace battery
Erratic display	Casual Misfunction Caused by Highly Vibration or Strongly Swinging	Zero setting
Number skip or frozen display	Internal error	Remove battery wait 1 minute and replace
The locking knob screw become loose	Too many rotating times	Tighten the locking knob and then tighten the screw